

Features

- Dimming port programming without driver power on
- CC/CV hybrid output
- High efficiency (Max 95%), active power factor correction
- Ultra low THD at light load
- Isolated 0~10V/ PWM/Rset dimming, Dim to off option
- 12V/200mA AUX Output
- UL listed with Class P

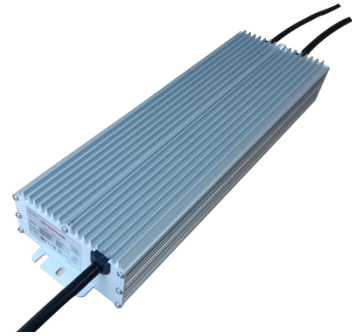

Description

800W LED Drivers offers digital programmable drivers with wide-range adjustable output current, together with 12V/200mA auxiliary output (optional) for smart lighting.

The output current of this series are programmable, and designed for 0-10V/PWM/Rset dimming applications.

Model Name Definition

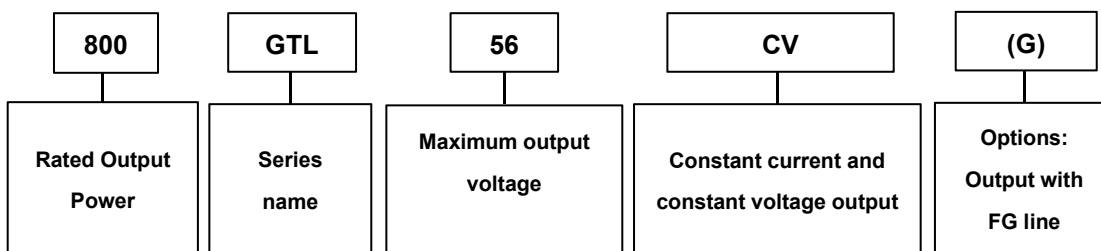

Specifications

Part Number	Max. Output Power	Programmable Current Region@CC	Output Voltage Range	Programmable Voltage Region@CV	Efficiency @277VAC
800GTL56CV(G)	800W	6.67-16.67A	28-56V	48-56 V	95%
800GTL80CV(G)	800W	4.71-11.76A	38-80V	64-80 V	95%
800GTL140CV(G)	800W	2.67-6.67A	67-140V	112-140V	95%
800GTL180CV(G)	800W	2.11-5.26A	84-180V	140-180 V	95%
800GTL240CV(G)	800W	1.57-3.92A	115-240V	192-240 V	95%

Note: Efficiency value is typical value.

Input Specifications

Parameter	Min.	Typ.	Max.	Notes
Input AC Voltage	90 Vac	-	305 Vac	
Input DC Voltage	127 Vdc	-	300 Vdc	
Input Frequency	47 Hz	-	63 Hz	
Leakage Current	-	-	0.75mA	At 277Vac / 60Hz input , grounding effectively
Input AC Current	-	-	3.3A	Measured at full load and 277 Vac input.

	-	-	7.4A	Measured at full load and 120 Vac input.
Inrush Current	-	-	65A	At 220Vac input, 25°C cold start,
PF	0.9	-	-	At 100-277Vac, full load
THD	-	-	20%	

Output Specifications

Parameter	Min.	Typ.	Max.	Notes
Output Current Tolerance	-5%Io set	-	5%Io set	At 25°C and full load condition
Total Output Current Ripple (pk-pk)	-	-	10%Io max	At 25°C and full load condition, 20 MHz BW
Startup Overshoot Current	-	-	20%Io max	At 25°C and full load condition
No Load Output Voltage		57V		800GTL56CV(G) only
Line Regulation	-	-	±1%	Measured at full load
Load Regulation	-	-	±1%	
Turn-on Delay Time	-	0.8 s	1.5 s	Measured at 120Vac input.
Temperature Coefficient of Io set	-0.03%/°C	-	0.03%/°C	Case temperature = 0°C ~Tc max
12V Auxiliary Output Voltage	11V	12 V	15 V	
12V Auxiliary Output Source Current	0 mA	-	200 mA	Return terminal is "Dim-"
OTP Tc	85°C	90°C	100°C	Output current will drop to 50%
SCP				Hiccup mode, Auto recover

General Specifications

Parameter	Min.	Typ.	Max.	Notes
Standby power	-	-	1.5 W	Measured at 220Vac/50Hz; Dimming off
MTBF	-	234,000 Hours	-	Measured at 220Vac input, 80%Load and 25°C ambient temperature (MIL-HDBK- 217F)
Lifetime	-	50,000 Hours	-	Measured at 220Vac input, 80%Load and 75°C case temperature; See lifetime vs. Tc curve for the details
Operating Case Temperature Tc	-40°C	-	90°C	There are three points could be maximum Tc point, depending on different Vac input and Vdc output. These three points position are shown in below mechanical drawing.
Operating Ambient Temperature Ta	-40°C	-	50°C	At 176-305Vac input, other voltage Ta 40° C max.
Storage Temperature	-40°C	-	+85°C	Humidity: 5%RH to 100%RH
Dimensions				
Inches (L × W × H)	14.02 × 3.89 × 1.81			
Millimeters (L × W × H)	356 × 98.8 × 46.1			
Net Weight	-	3.1kg	-	

Dimming Specifications

Parameter	Min.	Typ.	Max.	Notes
Absolute Maximum Voltage on the Vdim (+) Pin	-1 V	-	15 V	
Source Current on Vdim (+)Pin	90 uA	100 uA	110 uA	
Dimming Output Range	-	10%Io set	Io set	80%Io max ≤ Io set ≤ 100%Io max
	-	8%Io max	Io set	Io set < 80%Io max
Recommended Dimming Input Range	0 V	-	10 V	Default 0-10V dimming mode.
Dim off Voltage	0.3 V	0.5 V	0.8V	
Dim on Voltage	0.5V	0.7 V	1 V	
Hysteresis	-	0.2 V	-	
PWM_in High Level	9.8 V	10V	10.2 V	
PWM_in Low Level	-0.3 V	-	0.6 V	
PWM_in Frequency Range	200 Hz	-	3 KHz	
PWM_in Duty Cycle	1%	-	100%	
PWM Dimming off	3%	5%	7%	
PWM Dimming on	5%	7%	9%	

Safety & EMC Compliance

Safety Category	Standard
UL/CUL	UL8750,CAN/CSA-C22.2 No. 250.13-12
EMI Standards	Notes
FCC Part 15	ANSI C63.4:2009 Class B
	This device complies with Part 15 of the FCC Rules. Operation is subject to the following two conditions: (1) this device may not cause harmful interference, and (2) this device must accept any interference received, including interference that may cause undesired Operation.
EMS Standards	Notes
EN 61000-4-2	Electrostatic Discharge (ESD): 8 kV air discharge, 4 kV contact discharge
EN 61000-4-3	Radio-Frequency Electromagnetic Field Susceptibility Test-RS
EN 61000-4-4	Electrical Fast Transient / Burst-EFT: level 3, criteria A
EN 61000-4-5	Surge Immunity Test: AC Power Line: line to line 4 kV, line to earth 6 kV
EN 61000-4-6	Conducted Radio Frequency Disturbances Test-CS
EN 61000-4-8	Power Frequency Magnetic Field Test
EN 61000-4-11	Voltage Dips
EN 61547	Electromagnetic Immunity Requirements Applies To Lighting Equipment

Performance Curve

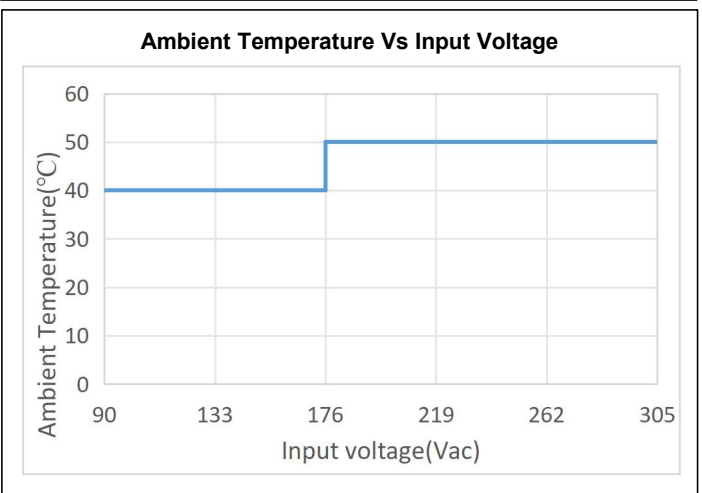
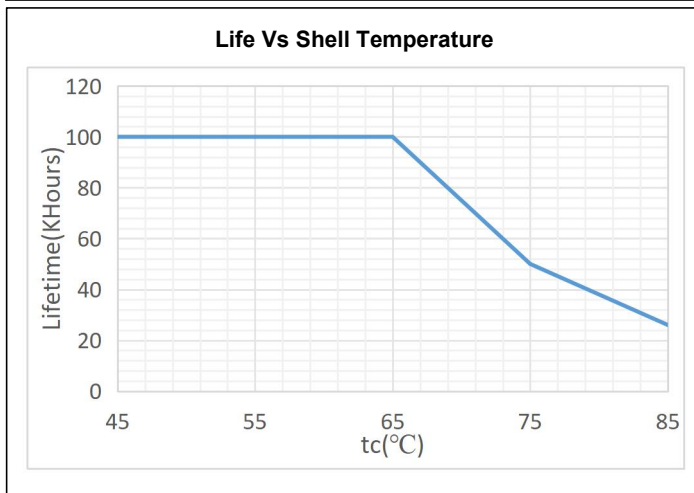
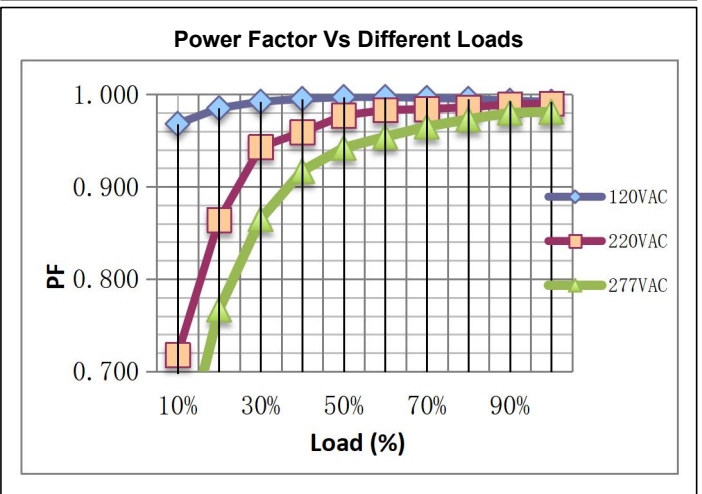
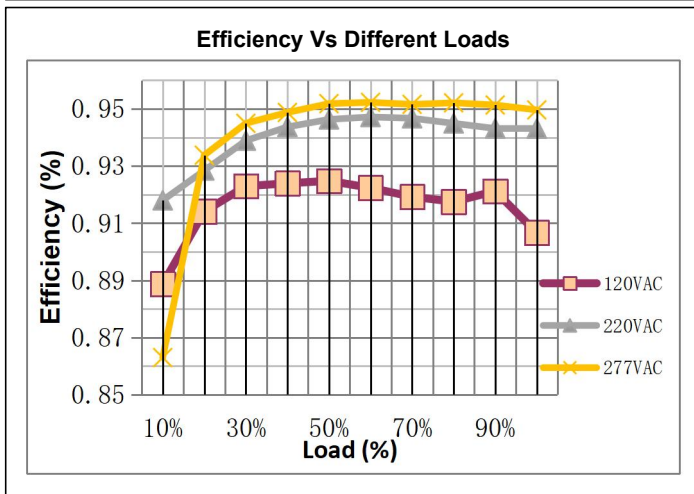
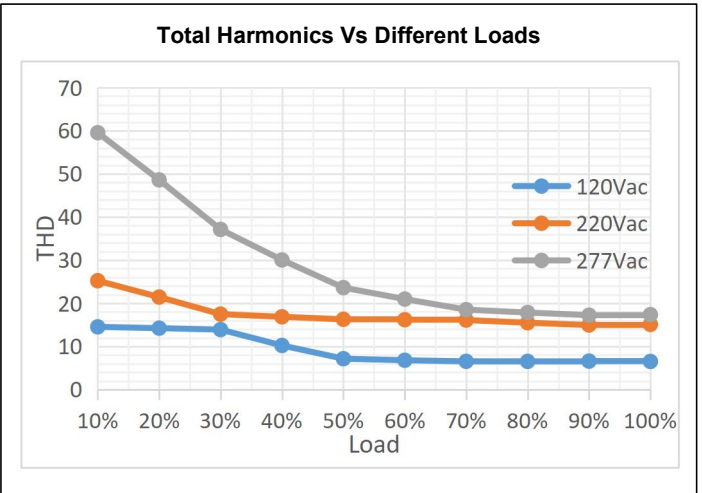
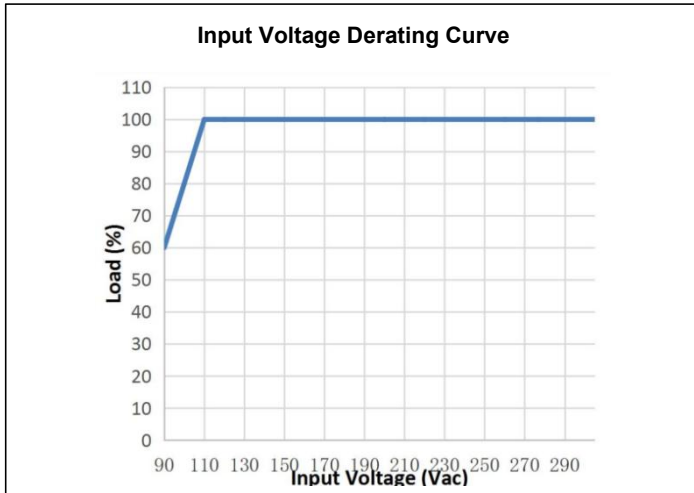

0-10V Analog Dimming & PWM Dimming

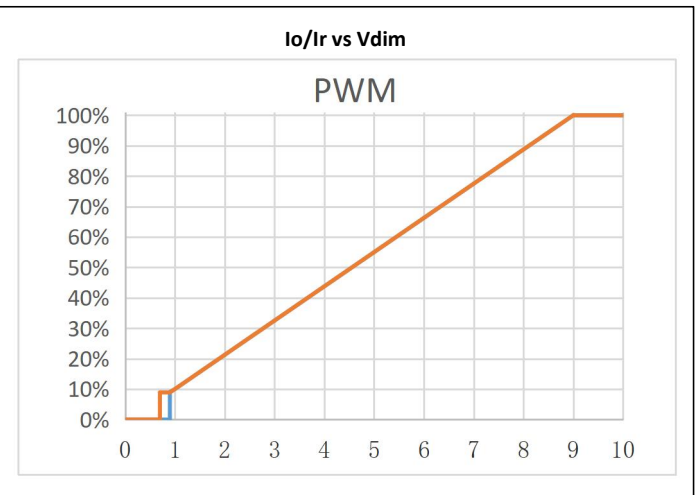
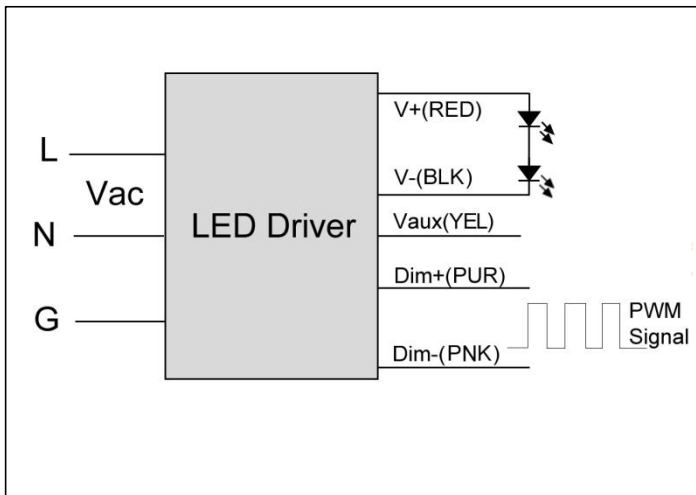
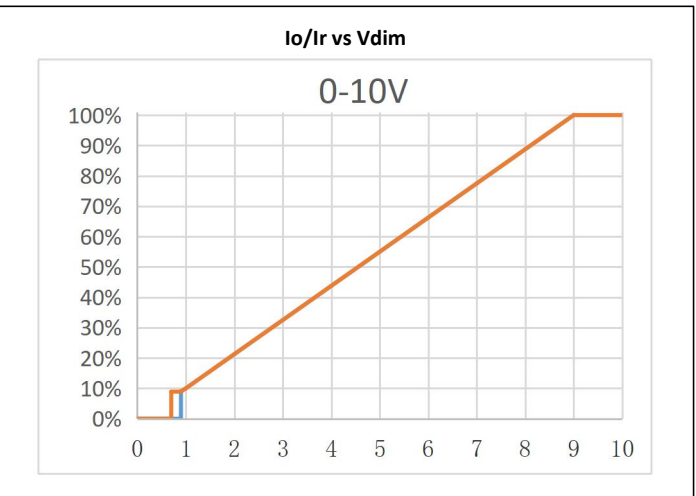
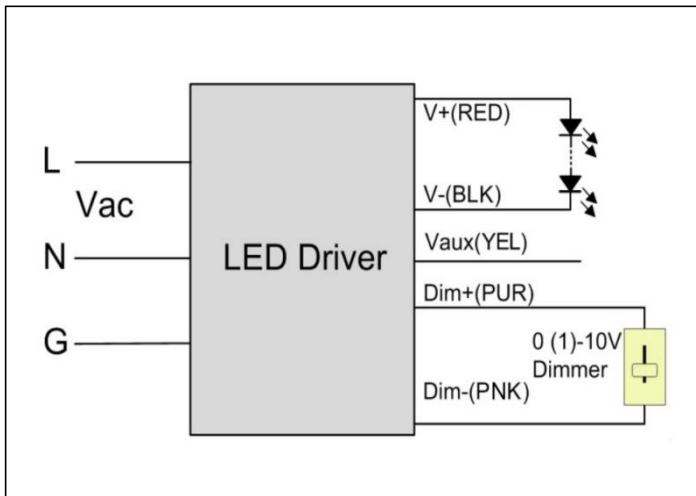

Note: The gray line in the dimming line will be changed to pink from January 1, 2022.

Programming Wiring Diagram

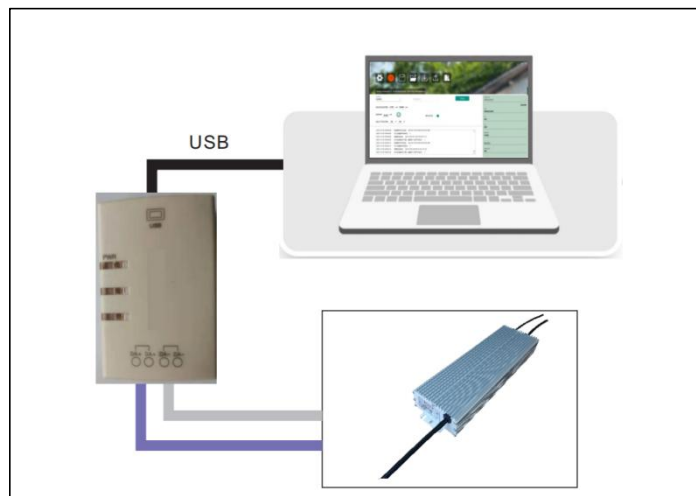

Mechanical Specification

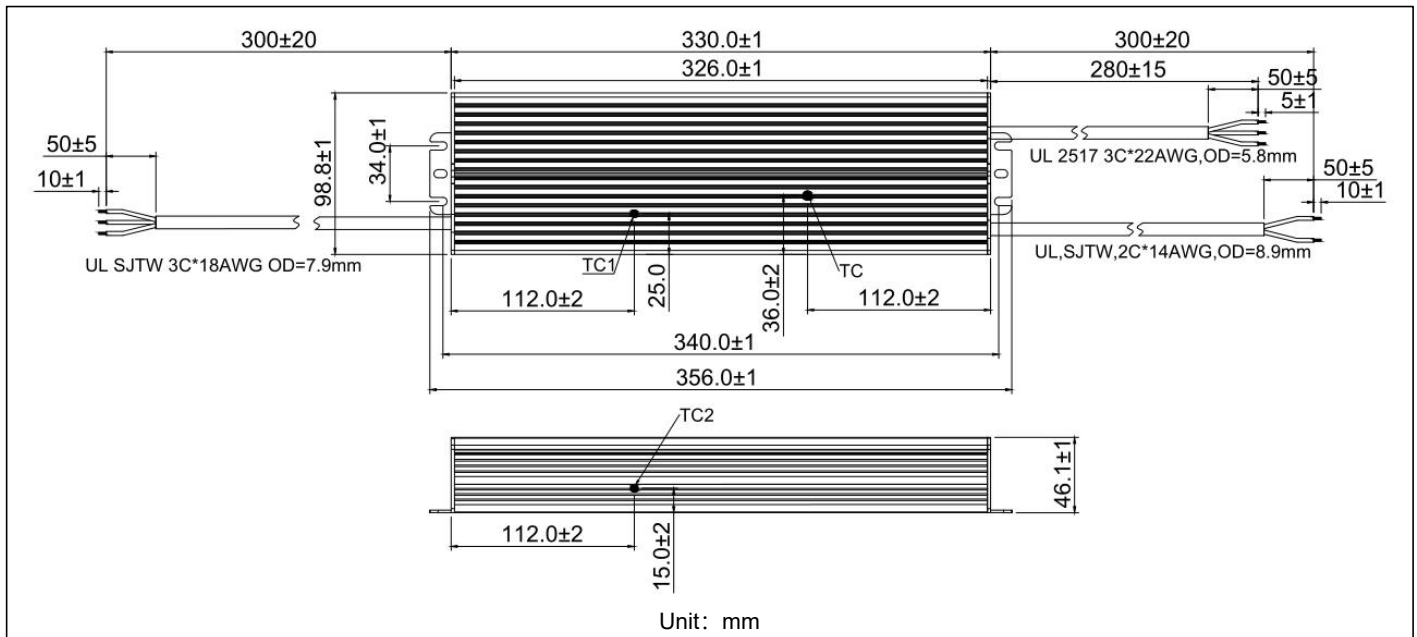

Revision History

Change Date	Rev.	Description of Change		
		Item	From	To
2021.9.27	V1.0			
2021.10.28	V1.1	Update Performance Curve		
2022.1.2	V1.2	Dimming line	gray	pink
2022.5.11	V1.3	Update Performance Curve		
		Update Lifetime Curve		
2023.12.6	V1.4	Update THD curve/lifetime curve		
		Net Weight	Typ: 2.8kg	Typ: 3.1kg
		Lifetime	Typ: 80,000hours	Typ: 50,000hours
		Operating Ambient Temperature Ta	Note: at 220-277Vac input	Note: At 176-305Vac input, other voltage Ta 40° C max.
		Update Mechanical Specification		
2024.12.25	V1.5	Dimming Output Range	Min: 10%lo set Min: 8%lo max	Typ.: 10%lo set Typ.: 8%lo max